

400 Series

403D-07

Compact Industrial and Construction Power

15.3 kW/20.5 bhp @ 3600 rev/min



The Perkins 400D range has been developed in consultation with our marketplace. This 0.7 litre, 3 cylinder engine compliments the exciting 400 Series product line-up, offering customers an ultra-compact, lightweight power unit that maintains all the customer benefits they can experience from other products in the range.

Ultra-compact power

- Up to 15.3 kW from an engine envelope of 0.08 m³
- Easy installation even in the smallest of machines

Clean and quiet

- Noise levels have been kept to a minimum
- Subjective harshness has been carefully controlled making the engine sound even quieter

Durable power

- Product design and process improvements enhance both engine reliability and durability
- An improved (advanced) governor, valve seat inserts, and new compliance testing deliver reliability with 6,000 hours durability
- A standard 2 year warranty demonstrates our confidence in durability and reliability

Low operating costs

- Approved for operation on biodiesel* concentrations of up to 20%
- Oil and filter changes are now set at 500 hours as standard
- Engine durability and reliability, the warranty offering and ease of installation combine to drive down the cost of ownership

Product support

- Through an experienced global network of distributors and dealers, fully trained engine experts deliver total service support around the clock, 365 days a year. They have a comprehensive suite of web based tools at their fingertips, covering technical information, parts identification and ordering systems, all dedicated to maximising the productivity of your engine
- Perkins actively pursues product support excellence by insisting our distribution network invest in their territory to provide you with a consistent quality of support across the globe
- Throughout the entire life of a Perkins engine, we provide access to genuine OE specification parts giving 100% reassurance that you receive the very best in terms of quality for lowest possible cost... wherever your Perkins powered machine is operating in the world

Certified to Stage IIIA and Tier 4b.

The 400 Series engine family continues to set new standards in the compact engine market. Developed alongside customers to fulfil their needs in the construction, materials handling, agricultural/turf, gen set and compressor markets, it is another class leading diesel range from Perkins.

Built to the most demanding standards, the 400D engines meet all the requirements of the off-highway emissions legislation for EC Stage IIIA/USA EPA Tier 3 and beyond.

Long 500 hour service intervals, a two year standard warranty, low noise and harshness, and a wide range of options make the 400 Series range the complete solution for compact power needs.

The 403D-07 is a 3 cylinder 0.7 litre unit delivering impressive performance, with low operating costs, in an ultra compact efficient package, ideally suited for a wide range of small off-highway applications.

Performance Data	Gross Intermittent (ISO/TR 14396)	Speed (rev/min)
Power Output (kW)	15.3	3600
Power Output (bhp)	20.5	3600
Peak Torque (Nm)	44.5	2200
Peak Torque (lbf ft)	32.8	2200

*Subject to conformance with ASTM D6751 and EN14214.

400 Series

403D-07

Engine Specification

- Cast iron engine block
- Flywheel and flywheel housing
- Fuel injection pump
- Spin on fuel filter
- Glow plug starting aid
- Lub oil sump
- Spin on lub oil filter
- Inlet manifold
- Cast iron exhaust manifold – side outlet
- Closed circuit breather
- Coolant pump belt driven
- Starter motor 12 volt
- Alternator 12 volt 14 amp
- ESOS
- Lub oil pressure switch
- Coolant temperature switch
- Choice of coolant fans
- Cold start capability to -30°C (aided)
- Gradeability 35° continuous

General Data

Number of cylinders	3 in-line
Bore and stroke	67 x 72 mm
Displacement	0.76 litres
Aspiration	Naturally aspirated
Cycle	4 stroke
Combustion system	Indirect injection
Compression ratio	23.5:1
Rotation	Anti-clockwise viewed on flywheel
Cooling system	Pressurised water
Total lubrication capacity	3.05 litres
Total coolant capacity	1.2 litres
Dimensions	Length 480 mm Width 371 mm Height 528 mm
Dry weight	71 kg

Final weight and dimensions will depend on completed specification.

Option Groups

A selection of optional items is available to enable you to prepare a specification precisely matched to your needs.

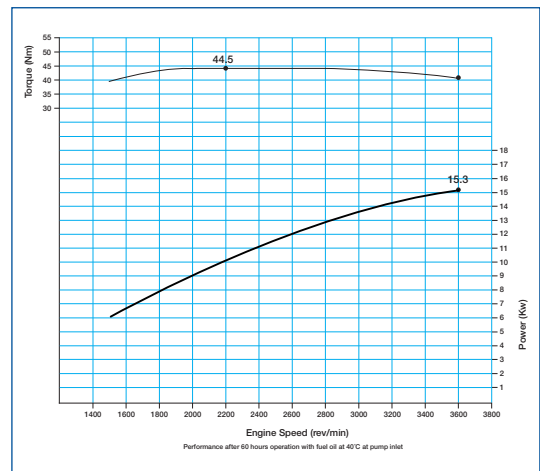
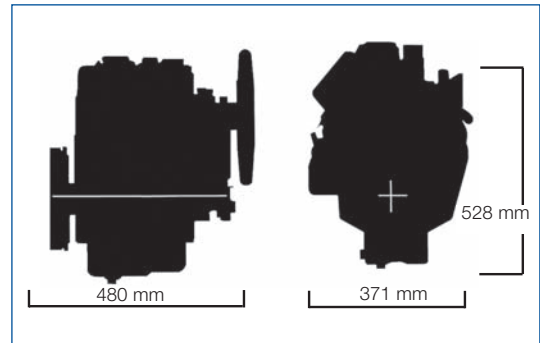

Perkins Engines Company Limited
 Peterborough PE1 5NA
 United Kingdom
 Telephone +44 (0)1733 583000
 Fax +44 (0)1733 582240
www.perkins.com

All information in this document is substantially correct at time of printing and may be altered subsequently
 Publication No. 1813/05/09 Produced in England ©2007 Perkins Engines Company Limited

Distributed by